

Rendszervázlat

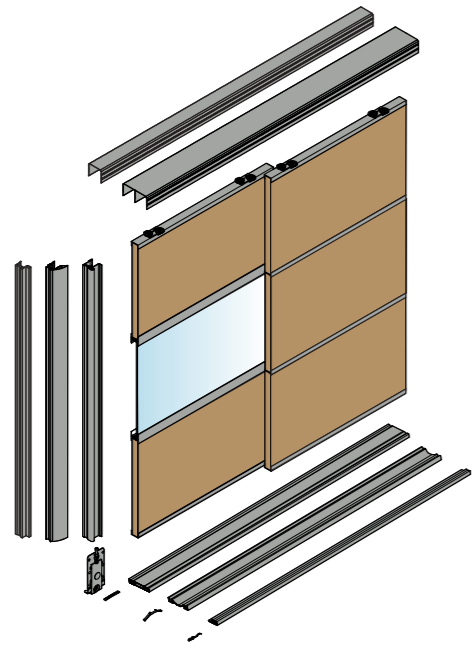

Rendszer jellemzői

- Szerelési lehetőség: korpuszban és falsíkok között futó ajtókhöz
- Alkalmazás: 1, 2 vagy 3 pályás, bútorlapra szerelt gardrób tolóajtókhöz
- Ajtólap megmunkálás: marás
- Magasságállítási lehetőség: +/- 3 mm
- Választható profil felületek a kiegészítő táblázat szerint



Teherbírás:
50 kg



Ajtóbetét anyaga:
fa, üveg



Megvezetés:
alsó vezetésű



Fék:
pozicionáló,
tolóajtó csillapító



Betétvastagság:
4/16/18 mm

Szerkezeti rajz

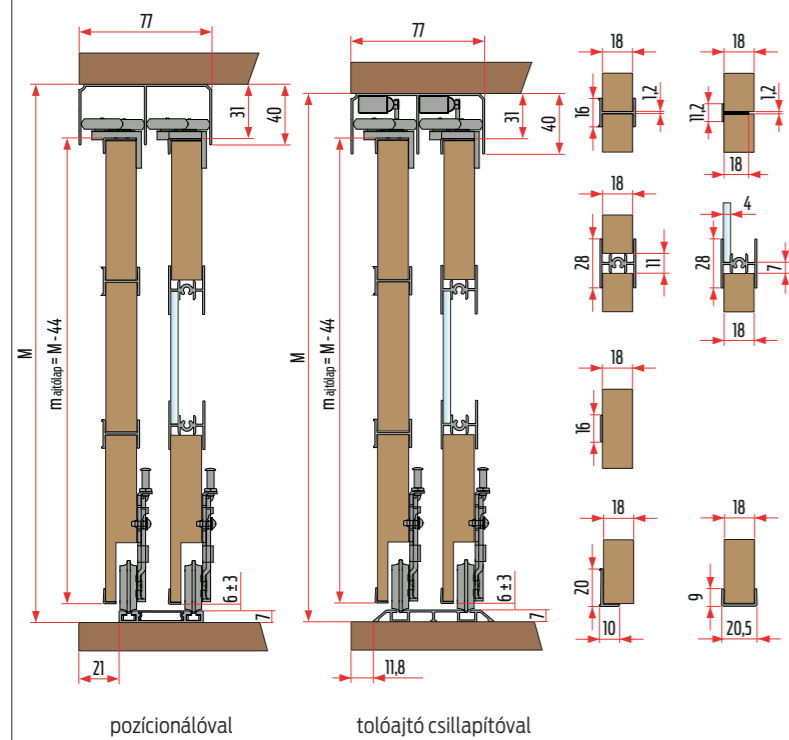

A gyártó fenntartja a jogot a termék méretének, színének, konstrukciójának megváltoztatására előzetes értesítés nélkül.

V03

Rendszervázlat

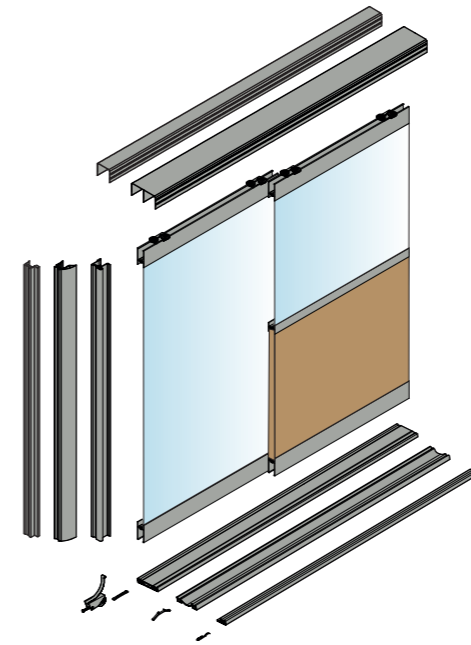

Rendszer jellemzői

- Szerelési lehetőség: korpuszban és falsíkok között futó ajtókhöz
- Alkalmazás: 1, 2 vagy 3 pályás, keretprofilos gardrób tolóajtókhöz
- Ajtólap megmunkálás: nem igényel
- Magasságállítási lehetőség: +/- 3 mm
- Választható profil felületek a kiegészítő táblázat szerint



Teherbírás:
50 kg



Ajtóbetét anyaga:
fa, üveg



Megvezetés:
alsó vezetésű



Fék:
pozicionáló,
tolóajtó csillapító





Betétvastagság:
4/16/18 mm

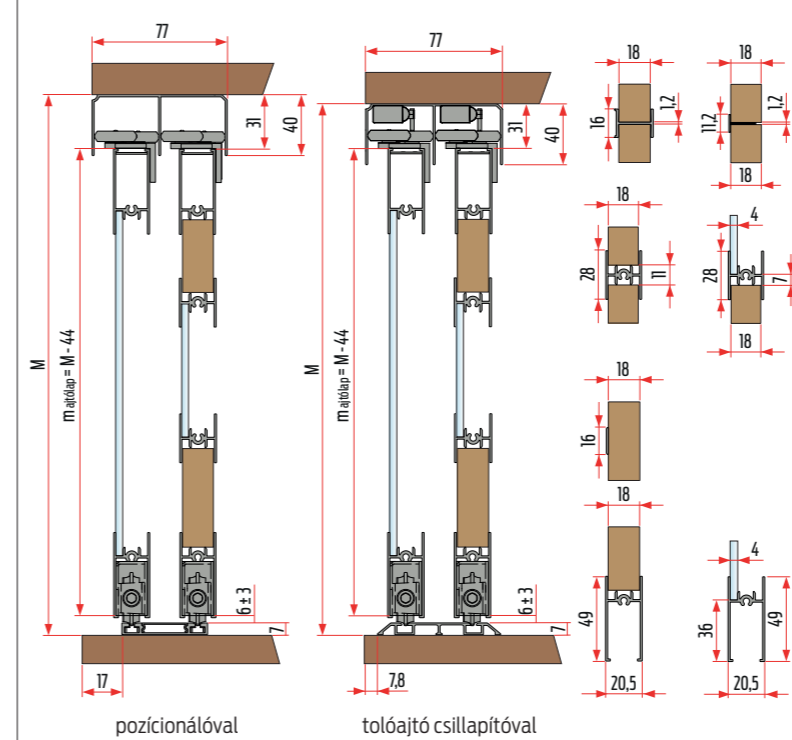

Szerkezeti rajz





Újdonságokról, termékekről és a teljes méretválasztékről bővebb információ: www.kamexgroup.hu

Görgő szettek

RAPID görgő szett - 1 ajtós			8083
			
x2	x2	x1	
8812	88101	88859100	
felső görgő	alsó görgő	műanyag pozicionáló	
fém	RAPID	Rapid alsó sínhez	





RAPID 2 FS görgő szett - 1 ajtós			12.112FS
			
x2	x2	x1	
11.601	11.602	11.054	
felső görgő	alsó görgő	fém pozicionáló	
RAPID	RAPID 2	Rapid alsó sínhez	



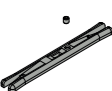

RAPID FIX FS görgő szett - 1 ajtós			12.113FS
			
x2	x2	x1	
11.601	11.603	11.054	
felső görgő	alsó görgő	fém pozicionáló	
RAPID	RAPID FIX	Rapid alsó sínhez	

Csillapítók

			
1671	1672	11.900	
tolóajtó csillapító	tolóajtó csillapító	tolóajtó közép	
(30kg)	(50kg)	csillapító (40kg)	

Görgő szettek

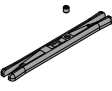
MULTIRAMA görgő szett - 1 ajtós				8084
				
x2	x2	x1	x2	
8812	8817	88859100	12.107	
felső görgő	alsó görgő	műanyag pozicionáló	VKP-L	
fém	MULTIRAMA	Rapid	felső görgő	
		alsó sínhez	kiegészítő szett	

RAMA görgő szett - 1 ajtós				8080
				
x2	x2	x1	x2	
8812	8810	88859100	12.107	
felső görgő	alsó görgő	műanyag pozicionáló	VKP-L	
fém	RAMA	Rapid	felső görgő	
		alsó sínhez	kiegészítő szett	



Csillapítók

			
1671	1672	11.900	
tolóajtó csillapító	tolóajtó csillapító	tolóajtó közép	
(30kg)	(50kg)	csillapító (40kg)	

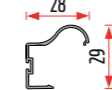
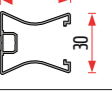
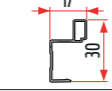
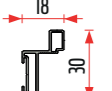
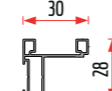
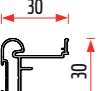
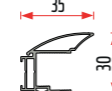

Fogantyúprofilok

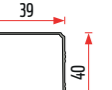
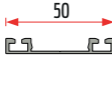
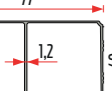
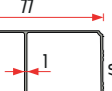
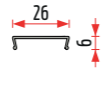
Megnevezés, rajz	hosszméret	felület	cikkszám	Megnevezés, rajz	hosszméret	felület	cikkszám
OMEGA R-18 	2,7m	alumínium	8860	OMEGA BRUSH 	2,7m	alumínium	827000
	2,7m	pezsgő	8864		2,7m	pezsgő	827004
	2,7m	arany	8865		2,7m	pezsgő	827004
INTERO 	2,7m	alumínium	8130	MODERN 	2,7m	alumínium	8720
	2,7m	pezsgő	8134		2,7m	pezsgő	8724
MODERN WIDE 	2,7m	alumínium	8730	ETA WIDE 	2,7m	alumínium	88271000
	2,7m	pezsgő	8734		2,7m	pezsgő	88271004
	2,7m	matt fehér	88730002		2,7m	inox	88271009
	2,7m	industrial fekete	88730008		2,7m	matt fehér	88271002
	2,7m	industrial antracit	88730014		2,7m	industrial fekete	88271008
RAMA WIDE 	2,7/3m	alumínium	8920	MULTIOMEGA WIDE 	2,7/3m	alumínium	8710
	2,7/3m	pezsgő	8924		2,7m	pezsgő	8714
	2,7m	inox	8929		2,7m	arany	8715
	2,7m	matt fehér	88920002		2,7m	inox	8719
	2,7m	industrial fekete	88920008		2,7m	matt fehér	88710002
	2,7m	industrial antracit	88920014		2,7m	industrial fekete	88710008
	2,7m	industrial vörösréz	88920013		2,7m	industrial antracit	88710014
	2,7m	industrial arany	88920015		2,7m	industrial vörösréz	88710013
					2,7m	industrial arany	88710015

Sínek

Felső csatorna SINGLE 	1/1,5/2/3/4/4,5/6m	alumínium	8740	Alsó sín RAPID 	1/1,5/2/3/4/4,5/6m	alumínium	88551000
	1/1,5/2/3/4/4,5/6m	pezsgő	8744		1/1,5/2/3/4/4,5/6m	pezsgő	88551004
	2/3/4/6m	matt fekete	88740002		2/3/4m	arany	8855
	2/3/4/6m	industrial fekete	88740008		2/3/4/6m	inox	88850009
Felső csatorna SOLID 	1/1,5/2/3/4/4,5/6m	alumínium	8940		2/3/4/6m	matt fehér	88551002
	1/1,5/2/3/4/4,5/6m	pezsgő	8944		2/3/4/6m	industrial fekete	88551008
Felső csatorna 	1/1,5/2/3/4/4,5/6m	alumínium	8840		2/3/4/6m	industrial antracit	88551014
	1/1,5/2/3/4/4,5/6m	pezsgő	8844		2/3/4/6m	industrial antracit	88551014
	2/3/4m	arany	8845		2/3/4/6m	industrial vörösréz	88551013
	2/3/4/6m	inox	8849		2/3/4/6m	industrial arany	88551015
	2/3/4/6m	matt fehér	88840002	Takaróprofil RAPID alsó sínhez 	1/1,5/2/3/4/4,5/6m	alumínium	88881000
	2/3/4/6m	industrial fekete	88840008		1/1,5/2/3/4/4,5/6m	pezsgő	88881004
	2/3/4/6m	industrial antracit	88840014	2/3/4m	arany	8885	
	2/3/4/6m	industrial vörösréz	88840013	2/3/4/6m	inox	8889	
	2/3/4/6m	industrial arany	88840015	2/3/4/6m	matt fehér	88881002	
	Felső csatorna TRIPLE 	2/3/4/6m	alumínium	88561000	2/3/4/6m	industrial fekete	88881008
2/3/4/6m		matt fehér	88561002	2/3/4/6m	industrial antracit	88881014	
2/3/4/6m		industrial fekete	88561008	2/3/4/6m	industrial vörösréz	88881013	
				2/3/4/6m	industrial arany	88881015	

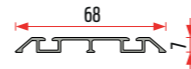

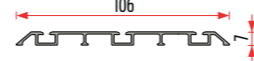
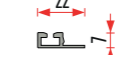



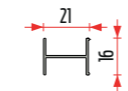
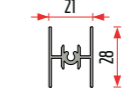
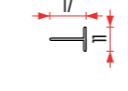
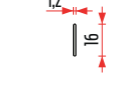
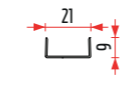
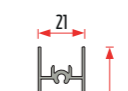
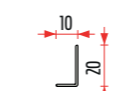
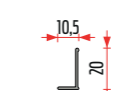

Sínek

Megnevezés, rajz	hosszméret	felület	cikkszám	Megnevezés, rajz	hosszméret	felület	cikkszám
Alsó sín RAPID IV kétoldalas ragasztószalaggal 	2/3/4/6m	alumínium	88564000	Alsó sín RAPID IV SINGLE kétoldalas ragasztószalaggal 	2/3/4/6m	alumínium	88562000
	2/3/4/6m	matt fehér	88564002		2/3/4/6m	matt fehér	88562002
	2/3/4/6m	industrial fekete	88564008		2/3/4/6m	industrial fekete	88562008
Alsó sín RAPID IV TRIPLE kétoldalas ragasztószalaggal 	2/3/4/6m	alumínium	88563000	Alsó sín RAPID SINGLE 	1/1,5/2/3/4/4,5/6m	alumínium	8750
	2/3/4/6m	matt fehér	88563002		3m	pezsgő	8754
	2/3/4/6m	industrial fekete	88563008				

Osztó és záró profilok

H osztó profil 	1/3m	alumínium	8180	Tükrös osztó profil 	1/3m	alumínium	8870	
	1/3m	pezsgő	8184		1/3m	pezsgő	8874	
	1/3m	arany	8185		1/3m	arany	8875	
	1/3m	inox	8189		1/3m	inox	8879	
	1/3m	matt fehér	88180002		1/3m	matt fehér	88870002	
	1/3m	industrial fekete	88180008		1/3m	industrial fekete	88870008	
	1/3m	industrial antracit	88180014		1/3m	industrial antracit	88870014	
	1/3m	industrial vörösréz	88180013		1/3m	industrial vörösréz	88870013	
	1/3m	industrial arany	88180015		1/3m	industrial arany	88870015	
	T osztó profil 	1/3m	alumínium		8510	Díszosztó profil 	1/3m	alumínium
1/3m		pezsgő	8514	1/3m	pezsgő		8894	
1/3m		matt fehér	88510002	1/3m	matt fehér		88890002	
1/3m		industrial fekete	88510008	1/3m	industrial fekete		88890008	
				1/3m	industrial antracit		88890014	
			1/3m	industrial vörösréz	88890013			
			1/3m	industrial arany	88890015			
U-18 profil 	1/3m	alumínium	8660	Vízszintes keretprofil 	1/3m		alumínium	8830
	1/3m	pezsgő	8664		1/3m		pezsgő	8834
	1/3m	arany	8665		1/3m		arany	8835
	1/3m	inox	8669		1/3m	inox	8839	
	1/3m	matt fehér	88660002		1/3m	matt fehér	88830002	
	1/3m	industrial fekete	88660008		1/3m	industrial fekete	88830008	
	1/3m	industrial antracit	88660014		1/3m	industrial antracit	88830014	
	1/3m	industrial vörösréz	88660013		1/3m	industrial vörösréz	88830013	
1/3m	industrial arany	88660015	1/3m		industrial arany	88830015		
L sarok profil sima 	1/3m	alumínium	8910		L sarok profil peremes 	1/3m	alumínium	8640
	1/3m	pezsgő	8914	1/3m		pezsgő	8644	
	1/3m	arany	8915	1/3m		arany	8645	
	1/3m	matt fehér	88910002					
	1/3m	industrial fekete	88910008					

Kiegészítők

							
kiskefe (ütköző kefe) öntapadó	nagykefe (porfogó kefe) öntapadó	kiskefe (ütköző kefe) behúzó	nagykefe (porfogó kefe) behúzó	WIDE kefe (ütköző kefe) behúzó	rögítő csipesz keféhez	üveg rögzítő adapter	keretcsavar Laguna keretprofilokhoz
SR/0088 (szürke) 90088001 (fehér) 90088006 (fekete)	SR/0089 (szürke) 90093001 (fehér)	SR/0090 (szürke) 90090001 (fehér) 90090006 (fekete)	SR/0091 (szürke) 90091001 (fehér) 90091006 (fekete)	SR/0099 (szürke) 90099151 (fehér) 90099006 (fekete)	11.162	8176	800