



Vers[^]atile

A flexible system for wooden folding doors
Sistema flessibile per porte pieghevoli in legno

The evolution of folding systems.

L'evoluzione dei sistemi pieghevoli.

www.ternoscorrevoli.com/versatile

Versatile

Terno Scorrevoli is always looking for innovative solutions to constantly improve its product catalogue. From this continuous research, Terno Scorrevoli presents **Versatile**, one extremely flexible system for multiple solutions: Versatile **allows for different configurations of folding doors:** bi-fold symmetrical doors, bi-fold asymmetrical doors, and multi-fold doors.

Terno Scorrevoli, da sempre alla ricerca di soluzioni innovative per migliorare costantemente il suo catalogo prodotti, presenta **Versatile**, un unico sistema per molteplici soluzioni, estremamente flessibile che **permette di realizzare diverse configurazioni di porte pieghevoli:** porte simmetriche a due ante, porte asimmetriche a due ante e porte a più ante.



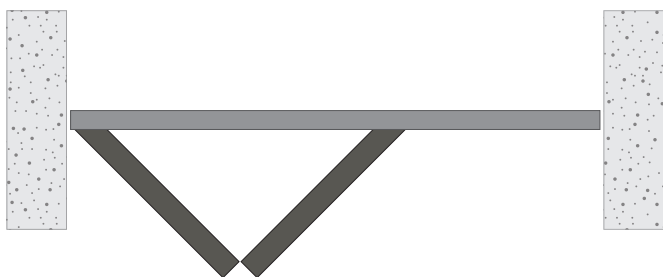

Symmetrical panels

In the situation of **panels with the same dimensions (1 + 1)**, the sliding trolley is instead fixed on the edge of the panel — **side fixing**: this application allows for a clear division of space, since the footprint of the panels in the open position is **entirely confined to one room**.

Pannelli simmetrici

Nella situazione di **pannelli con le stesse dimensioni (1 + 1)**, il carrello scorrevole viene fissato sul bordo del pannello — **fissaggio laterale**: questa applicazione consente una chiara divisione dello spazio, poiché l'ingombro dei pannelli in posizione aperta è **interamente confinato in una stanza**.

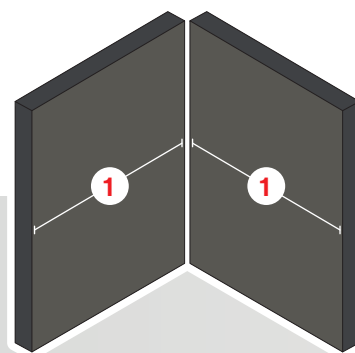

FOLDING DOORS WITH SYMMETRICAL PANELS
PORTE A LIBRO CON PANNELLI SIMMETRICI



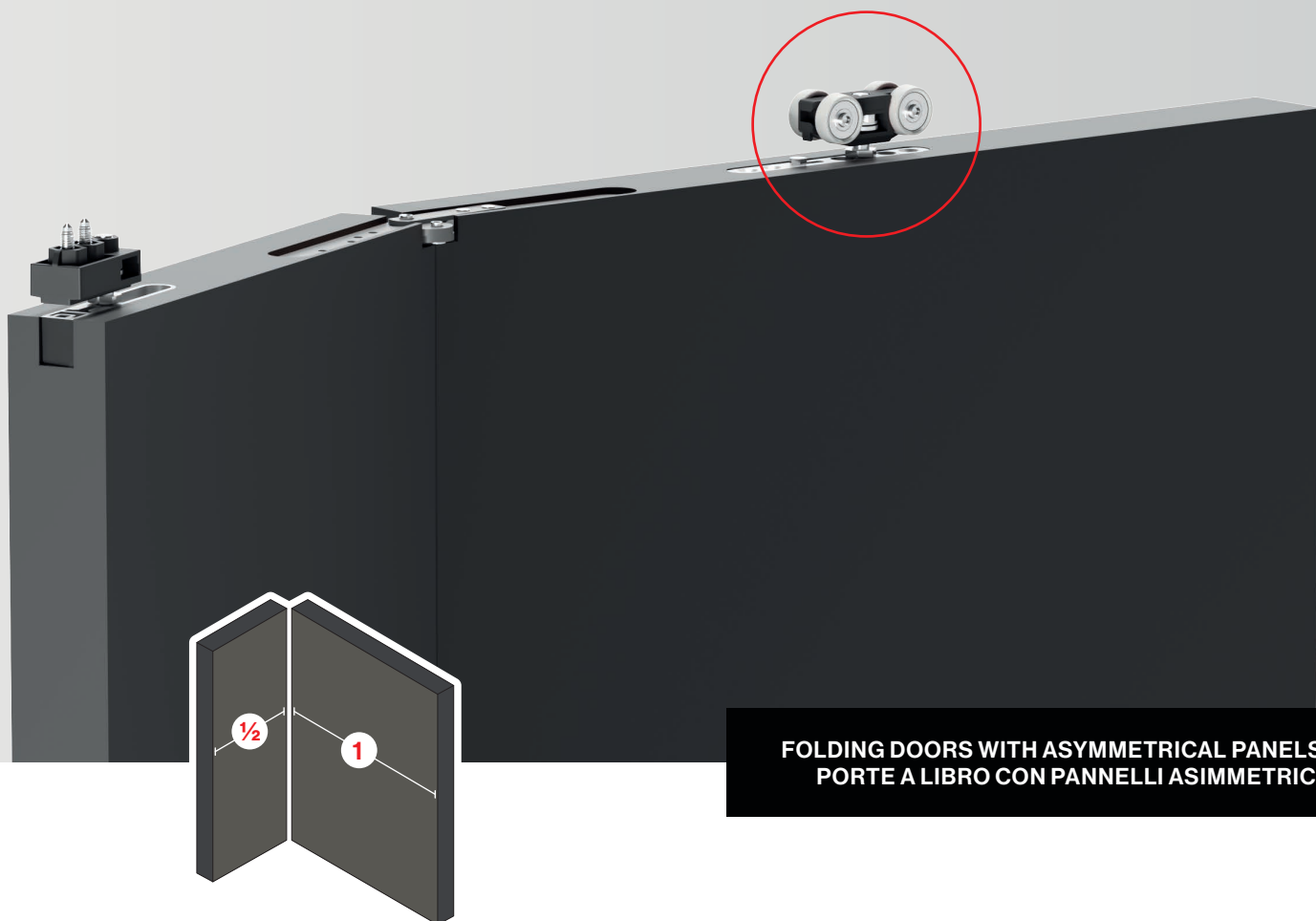

FOLDING DOORS WITH ASYMMETRICAL PANELS
PORTE A LIBRO CON PANNELLI ASIMMETRICI

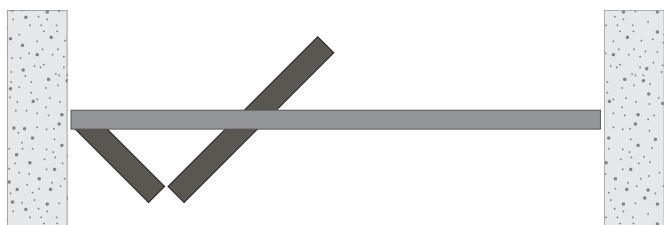

Asymmetrical panels

In the case of **panels with different sizes** (the first panel is half as wide as the next ones - $\frac{1}{2} + 1$), the sliding trolley is fixed in the middle of the panel — **middle fixing**: this configuration allows folding doors to be made in limited spaces, distributing the footprint of the **packed panels between the two rooms** when the door is open.

Pannelli asimmetrici

Nel caso di **pannelli di dimensioni diverse** (il primo pannello è largo la metà dei successivi - $\frac{1}{2} + 1$), lo scorrevole viene fissato al centro del pannello — **fissaggio centrale**: questa configurazione permette di realizzare porte a libro in spazi limitati, distribuendo **l'ingombro dei pannelli tra i due ambienti** quando la porta è aperta.



Versatile system with asymmetrical doors optimizes limited space use, offering more flexibility. The arrangement maximizes efficiency, allowing the folding doors to adapt to specific space needs for optimal interior organization. **This configuration adds a contemporary touch and is advantageous in settings where space management is crucial, providing both practicality and style.**

Il sistema Versatile con porte asimmetriche massimizza lo spazio limitato, offrendo flessibilità e efficienza. Le ante a libro si adattano alle esigenze di spazio, garantendo un'organizzazione ottimale. **Questa configurazione da un tocco contemporaneo ed è ideale per ambienti dove lo spazio è prezioso, unendo praticità e stile.**

A flexible folding system that fits in any room

Versatile is a **state-of-the-art and very flexible folding door system**. Dimensionally it can adapt to many needs: in width it works in **bi-fold** and **multi-fold** mode to create single doors, but also to close larger compartments. In height it can create **doors up to 3 meters**.

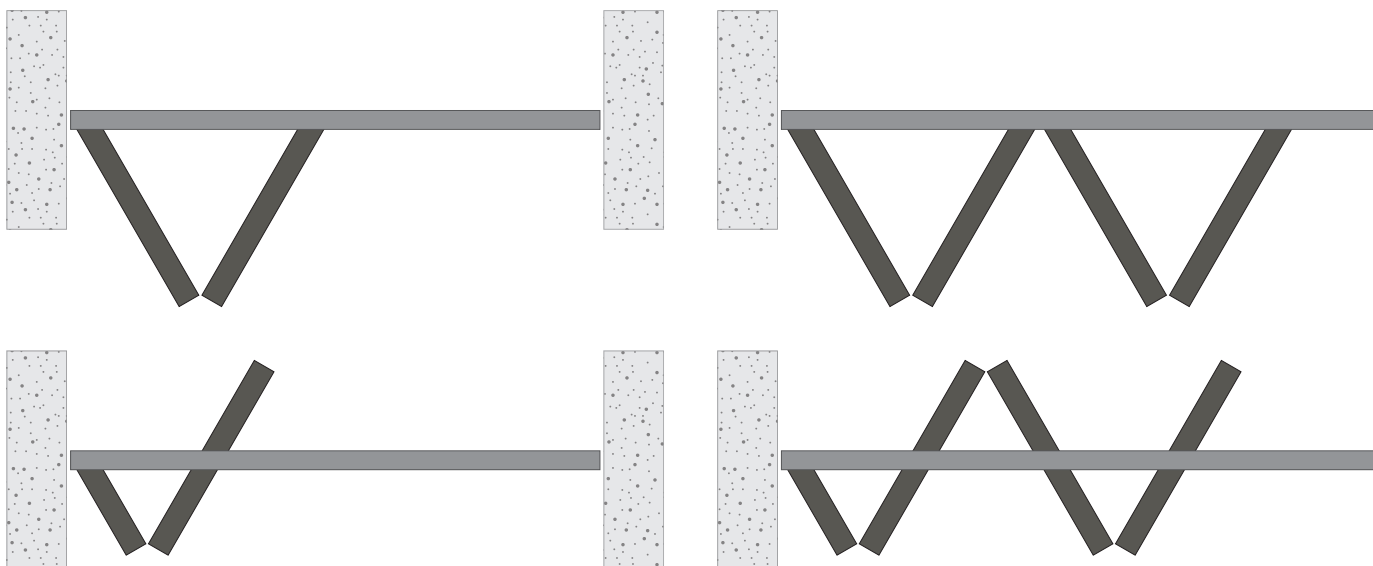

BI-FOLD

MULTI-FOLD

Un sistema pieghevole flessibile che si adatta a qualsiasi ambiente

Versatile è un sistema di **porte a libro all'avanguardia e molto flessibile**. Dimensionalmente può adattarsi a molte esigenze: in larghezza funziona in modalità **bi-fold** e **multi-fold** per creare porte singole, ma anche per chiudere vani più grandi. In altezza può creare **porte fino a 3 metri**.

System can also be installed in two ways: the track can be recessed into the jamb, or attached externally to the jamb directly under the ceiling.

Il sistema può essere installato in due modi: il binario può essere incassato nello stipite o fissato esternamente allo stipite direttamente sotto il soffitto.

Perfect panel alignment

A solution to many problems

A special feature of Versatile System is the **magnetic aligner**: a magnetic insert in the panels that ensures, when closing the door, that the various **panels align correctly**. This results in a complete and linear closing of the door.

Magnetic aligner has an important feature: it's **adjustable in order to correct the gap between the door panels**.

The magnetic aligner is a **quality solution** that, in addition to providing a silent operation, allows for much easier installation, as **panels can be mounted one at a time**.

Una caratteristica speciale del sistema Versatile è l'**allineatore magnetico**: un inserto magnetico nei pannelli che assicura, al momento della chiusura della porta, il **corretto allineamento dei vari pannelli**. L'allineatore magnetico ha una caratteristica importante: è **regolabile per correggere lo spazio tra i pannelli della porta**. L'allineatore magnetico è una **soluzione di qualità** che, oltre a garantire un funzionamento silenzioso, consente un'installazione molto più semplice, in quanto **i pannelli possono essere montati uno alla volta**.



Una soluzione a molti problemi

Allineamento perfetto dei pannelli

Only 6 mm · Upper Gap
Solo 6 mm · Luce Superiore



A perfect stacking of the panels thanks to the butt hinges

Thanks to the included butt hinges, with panel thicknesses greater than 40 mm, the system ensures precise and aligned door packing when opening.

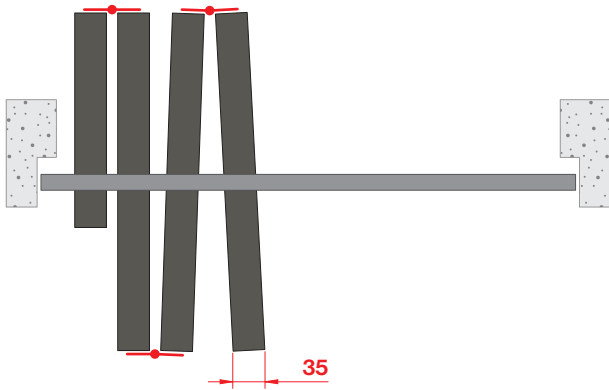

Un impacchettamento perfetto dei pannelli grazie alle cerniere a libro

Grazie alle cerniere a libro incluse, con pannelli di spessore superiore a 40 mm, il sistema garantisce un impacchettamento preciso e allineato dell'anta in apertura.

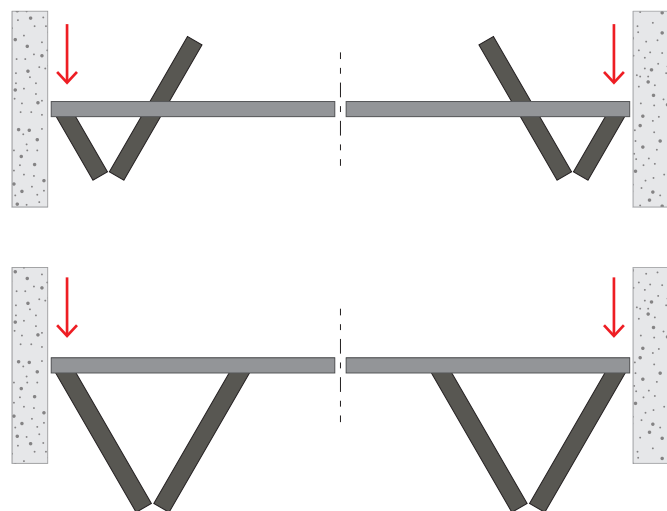
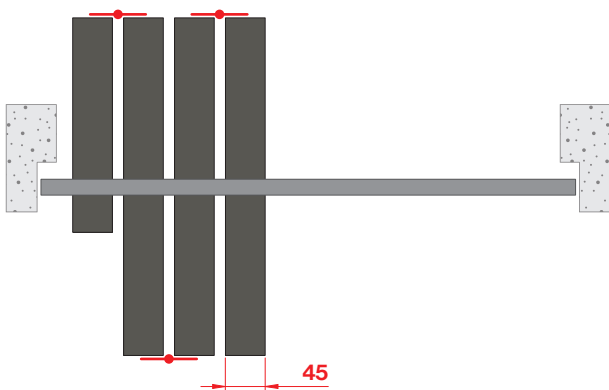
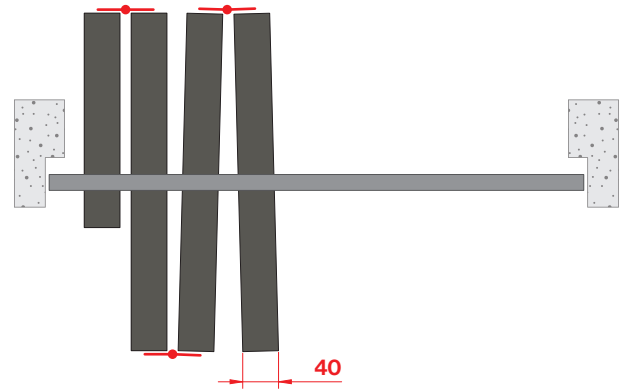

Adaptable Space Solutions

Versatile offers extraordinary adaptability with its **reversible design**, allowing installation on either side for incredible versatility in space design. Its flexibility extends beyond the direction of opening, adapting seamlessly to various aesthetic and architectural contexts. Simplifying space management, **Versatile system stands as a creative solution for the evolving needs of contemporary spaces.**

Soluzioni di spazio adattabili

Versatile si distingue per la sua straordinaria adattabilità grazie al **design reversible**, installabile su entrambi i lati per una versatilità senza pari nella progettazione degli spazi. Oltre alla direzione di apertura, si adatta perfettamente a vari contesti estetici e architettonici. Semplificando la gestione dello spazio, **il sistema Versatile è una soluzione creativa per gli ambienti moderni in continua evoluzione.**

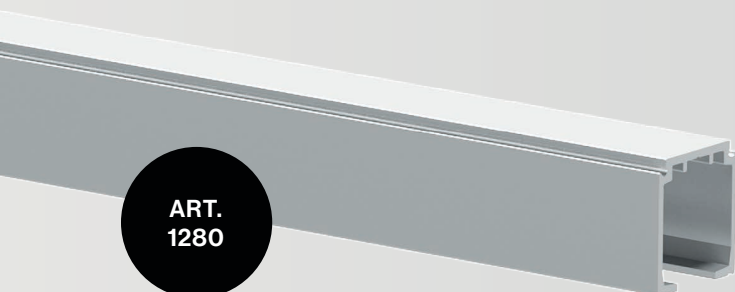
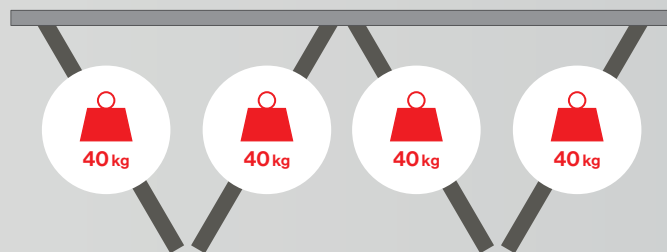
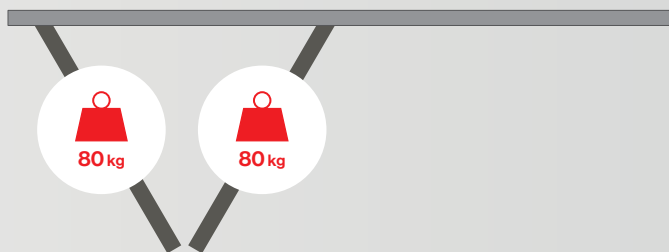

ART.
1280

For configurations up to 160 kg

1280 profile — A benefit for the stock

A single track both for the folding system and all Fluid sliding systems

Per configurazioni fino a 160 kg

Profilo 1280 - Un vantaggio per lo stock

Un binario unico sia per il sistema pieghevole che per tutti i sistemi scorrevoli Fluid

High-performance movements thanks to Fluid technology

The system's slides integrates trolleys from patented Fluid technology for extremely high-performance, linear and uniform movements, even on irregular surfaces.

Sliding trolley wheels are equipped with coated bearings of large dimension and memory shape independent stabilization spacer, laterally positioned.

These stabilization spacer, inserted between bearings and related rigid support, allow the wheels to slide uniformly leaning on the track, even in case of wall defects or not aligned installation of the track itself.

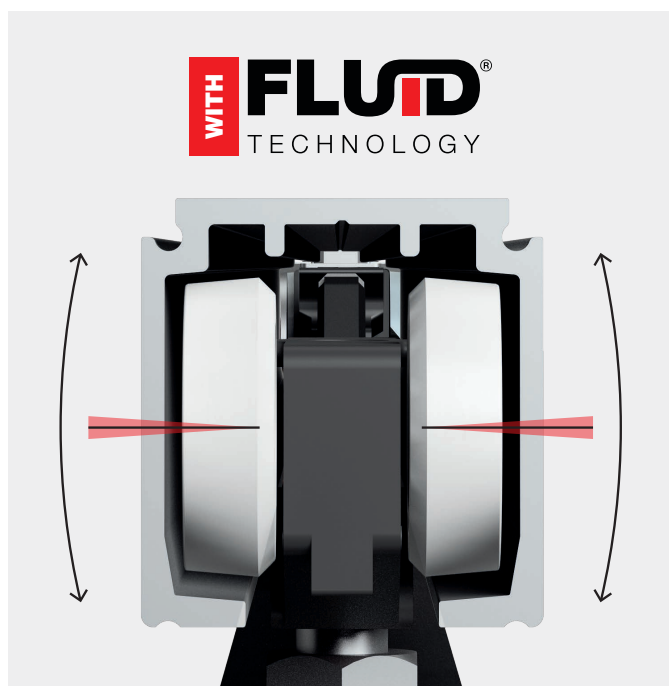
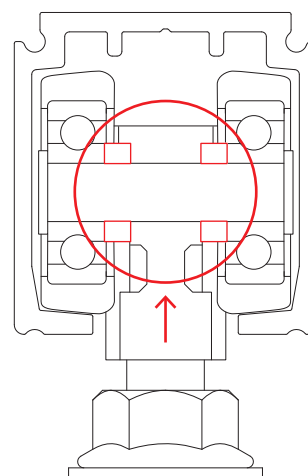

Movimenti ad alte prestazioni, grazie alla tecnologia Fluid

Gli scorrevoli del sistema integrano carrelli dalla tecnologia brevettata Fluid per movimenti estremamente performanti, lineari e uniformi, anche su superfici irregolari.

Le ruote degli scorrevoli sono dotate di cuscinetti rivestiti di grandi dimensioni e di distanziali di stabilizzazione indipendenti a memoria di forma, posizionati lateralmente.

Questi distanziali, inseriti tra i cuscinetti e il relativo supporto rigido, permettono alle ruote di scorrere uniformemente appoggiandosi al binario, anche in caso di difetti delle pareti o di installazione non allineata del binario stesso.



K		Complete kit / Kit completo			
058					
1	First Door Prima Porta				
2	First Door Floor guide Prima Porta Guida Pavimento				
1 Max 2400 mm					
2 Max 3000 mm					
1			Without hinges with magnetic aligner Senza cerniere con allineatore magnetico		
2			Hinges without aligners Cardini senza allineatori		
5			Butt hinges with magnetic aligner Cerniere a libro con allineatore magnetico		
2 Max 3000 mm					
1					
5					
41 Painted black Verniciato nero					
42 Painted silver Verniciato argento					
K		Complete kit / Kit completo			
058					
3	Second Door Seconda Porta				
1 Max 2400 mm					
2 Max 3000 mm					
1					
5					
4	Second Door Floor guide Seconda Porta Guida Pavimento				
1 Max 2400 mm					
2 Max 3000 mm					
1					
5					
41 Painted black Verniciato nero					
42 Painted silver Verniciato argento					

EXAMPLE / ESEMPIO

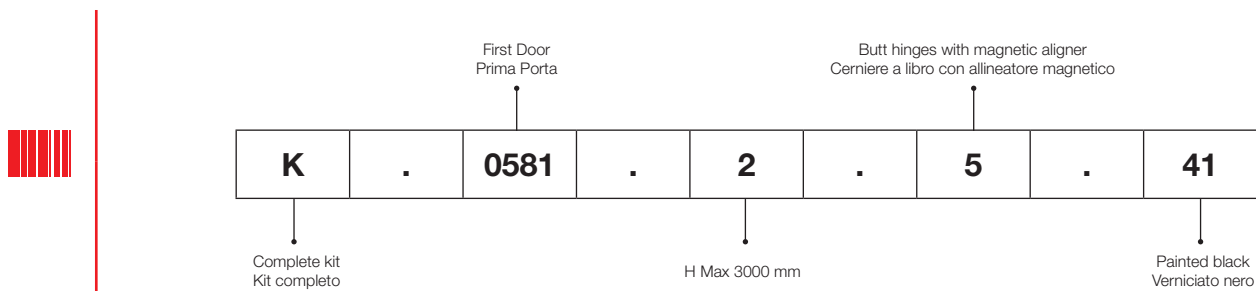

Tracks / Binari		ALUMINUM FINISHES CODES / CODICI FINITURE ALLUMINIO	
CODE / CODICE	FINISH COLOR / COLORE FINITURA		
8 01 0.0	01	A	Anodized Silver / Argento
8 14 0.0	14	N	Anodized Black / Nero
			STANDARD
			SPECIAL



Versatile

A flexible system for wooden folding doors
Sistema flessibile per porte pieghevoli in legno

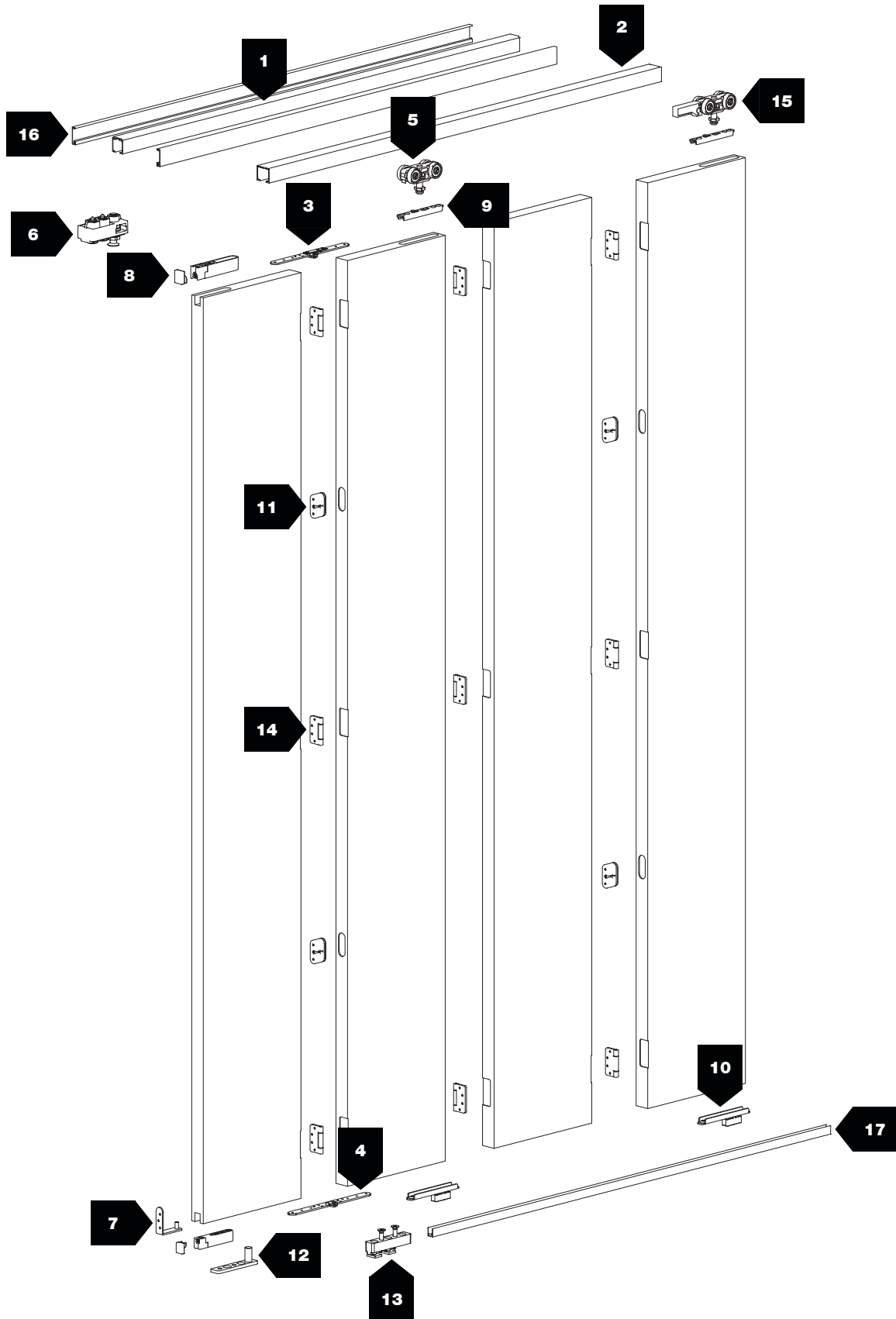

Max 160 Kg

N°	Barcode	Image	kg	N°	Barcode	Image	kg
1	1280 8 01 0.01280			9	3145		
2	3420 8 01 0.03420			10	3146		
3	1135			11	3147		
4	1138			12	3148		
5	3141			13	3149		
6	3142			14	3137		
7	3143			15	3139		
8	3144			16	2772		
				17	630		

Versatile

A flexible system for wooden folding doors
Sistema flessibile per porte pieghevoli in legno

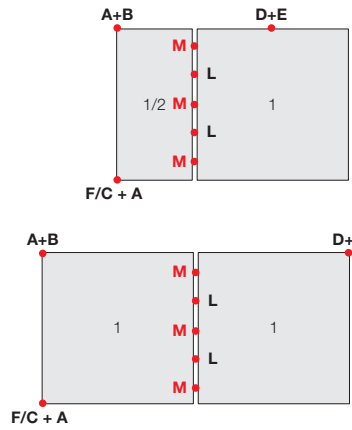
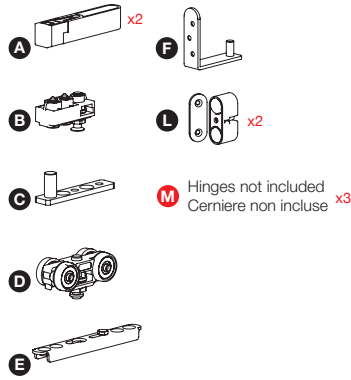
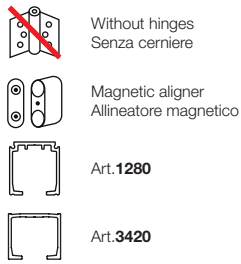

Kit for first door
Kit per prima porta



Kit for first door
Kit per prima porta



CODE	FINISHES / FINITURE	
K.0581.1.1	.41	Max 2400 mm

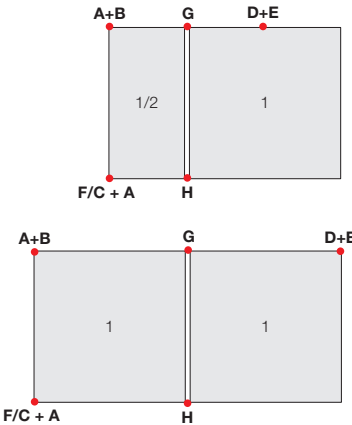
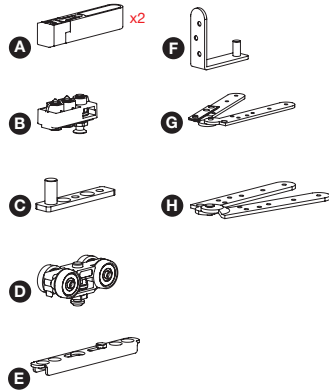

Kit for first door
Kit per prima porta



Kit for first door
Kit per prima porta



CODE	FINISHES / FINITURE	
K.0581.1.2	.41	Max 2400 mm

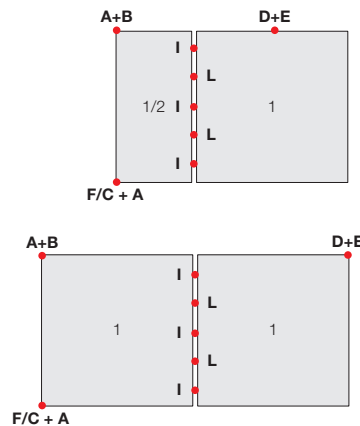
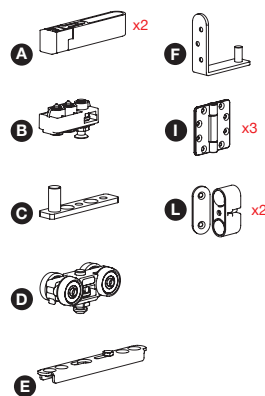
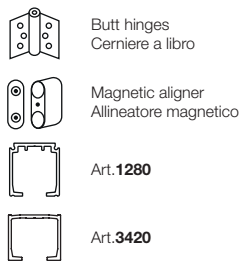

Kit for first door
Kit per prima porta



Kit for first door
Kit per prima porta



CODE	FINISHES / FINITURE	
K.0581.1.5	.41 .42	Max 2400 mm

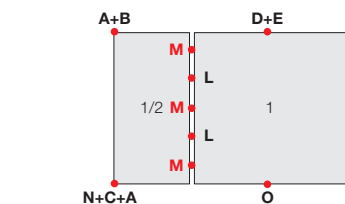
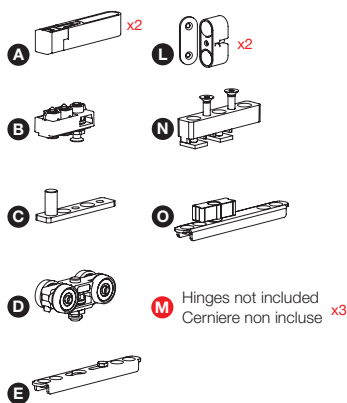

Kit for first door with floor guide
Kit per prima porta con guida pavimento

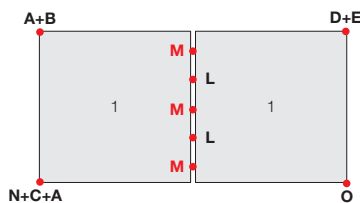

Kit for first door with floor guide
Kit per prima porta con guida pavimento



Without hinges
Senza cerniere



Magnetic aligner
Allineatore magnetico



Art. 1280



Art. 630

CODE	FINISHES / FINITURE	
K.0582.1.1	.41	Max 2400 mm

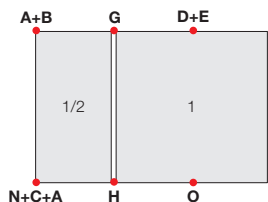
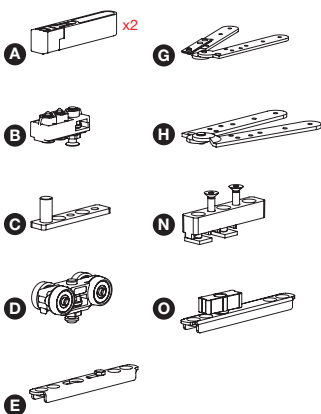

Kit for first door with floor guide
Kit per prima porta con guida pavimento

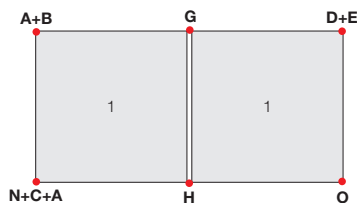

Kit for first door with floor guide
Kit per prima porta con guida pavimento



Hinges
Cardini



Without aligners
Senza allineatori



Art. 1280



Art. 630

CODE	FINISHES / FINITURE	
K.0582.1.2	.41	Max 2400 mm

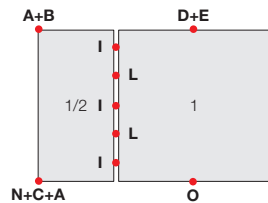
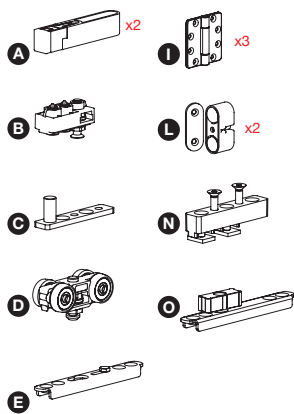

Kit for first door with floor guide
Kit per prima porta con guida pavimento

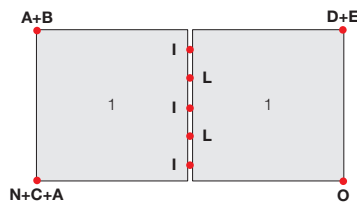

Kit for first door with floor guide
Kit per prima porta con guida pavimento



Butt hinges
Cerniere a libro



Magnetic aligner
Allineatore magnetico



Art. 1280



Art. 630

CODE	FINISHES / FINITURE	
K.0582.1.5	.41 .42	Max 2400 mm

Versatile

A flexible system for wooden folding doors
Sistema flessibile per porte pieghevoli in legno



Without hinges
Senza cerniere



Magnetic aligner
Allineatore magnetico



Art.1280



Art.3420

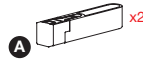

A

x2



F



B



L

x3

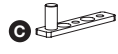

C

M Hinges not included
Cerniere non incluse x4



D



E

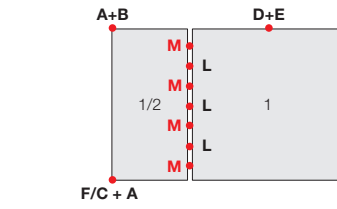

Kit for first door
Kit per prima porta

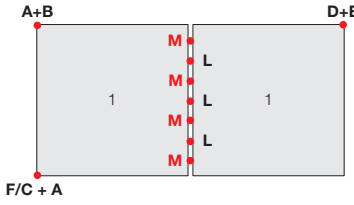

Kit for first door
Kit per prima porta



CODE	FINISHES / FINITURE	
K.0581.2.1	.41	Max 3000 mm



Butt hinges
Cerniere a libro



Magnetic aligner
Allineatore magnetico



Art.1280



Art.3420

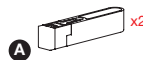

A

x2



F



B



I

x4

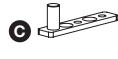

C



L

x3



D

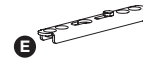

E

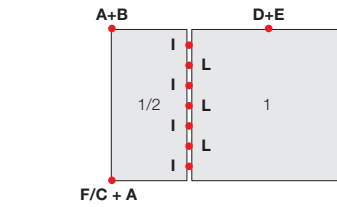

Kit for first door
Kit per prima porta

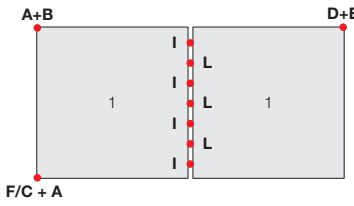

Kit for first door
Kit per prima porta



CODE	FINISHES / FINITURE	
K.0581.2.5	.41 .42	Max 3000 mm

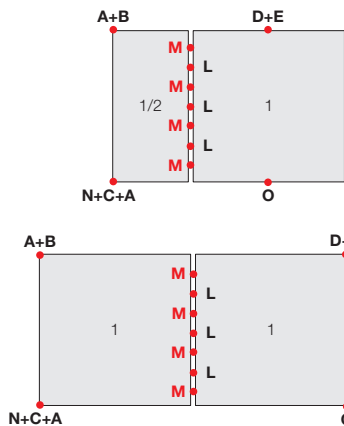
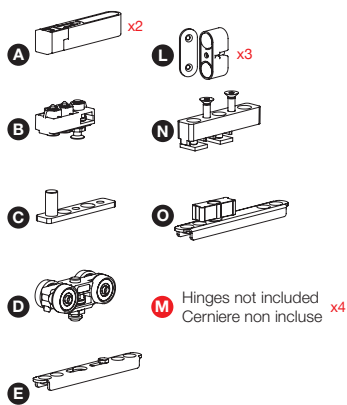

Kit for first door with floor guide
Kit per prima porta con guida pavimento



Kit for first door with floor guide
Kit per prima porta con guida pavimento

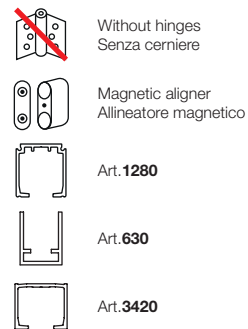

CODE	FINISHES / FINITURE	Max 3000 mm
K.0582.2.1	.41	Max 3000 mm

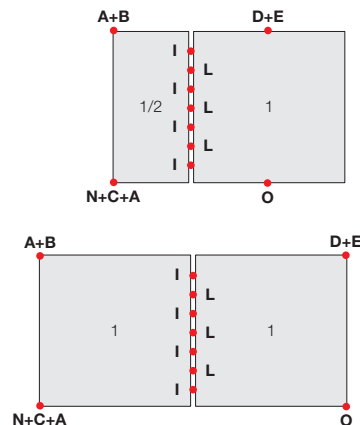
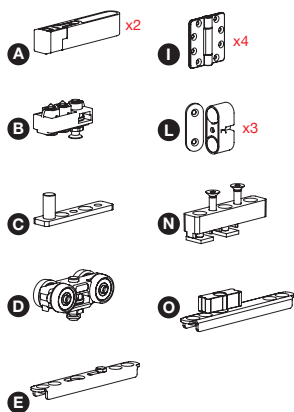

Kit for first door with floor guide
Kit per prima porta con guida pavimento



Kit for first door with floor guide
Kit per prima porta con guida pavimento

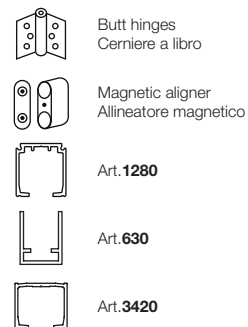

CODE	FINISHES / FINITURE	Max 3000 mm
K.0582.2.5	.41 .42	Max 3000 mm

Versatile

A flexible system for wooden folding doors
Sistema flessibile per porte pieghevoli in legno



Without hinges
Senza cerniere



Magnetic aligner
Allineatore magnetico



Art.1280

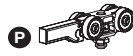
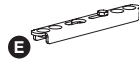

M Hinges not included
Cerniere non incluse x6

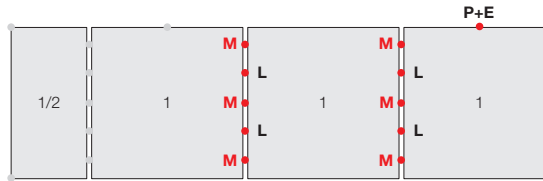

Kit for second door
Kit per seconda porta



CODE	FINISHES / FINITURE		
K.0583.1.1	.41		Max 2400 mm



Butt hinges
Cerniere a libro



Magnetic aligner
Allineatore magnetico



Art.1280

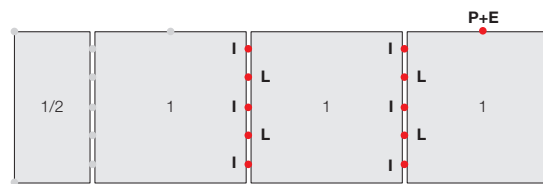
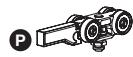
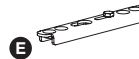

Kit for second door
Kit per seconda porta



CODE	FINISHES / FINITURE		
K.0583.1.5	.41	.42	Max 2400 mm



Without hinges
Senza cerniere



Magnetic aligner
Allineatore magnetico



Art.1280



M Hinges not included
Cerniere non incluse x8

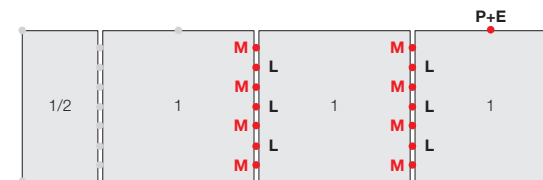

Kit for second door
Kit per seconda porta



CODE	FINISHES / FINITURE		
K.0583.2.1	.41		Max 3000 mm



Butt hinges
Cerniere a libro



Magnetic aligner
Allineatore magnetico



Art.1280

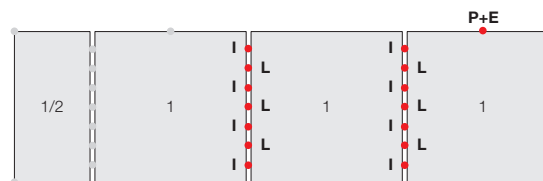
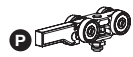
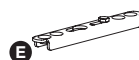

Kit for second door
Kit per seconda porta



CODE	FINISHES / FINITURE		
K.0583.2.5	.41	.42	Max 3000 mm

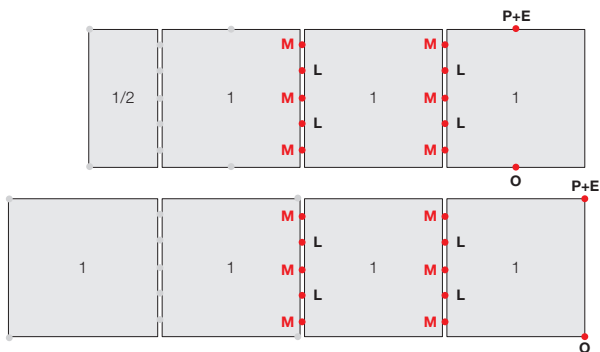
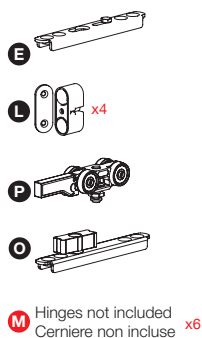

Kit for second door with floor guide
Kit per seconda porta con guida pavimento



Kit for second door with floor guide
Kit per seconda porta con guida pavimento



Without hinges
Senza cerniere



Magnetic aligner
Allineatore magnetico



Art. 1280



Art. 630

CODE	FINISHES / FINITURE		
K.0584.1.1	.41		Max 2400 mm

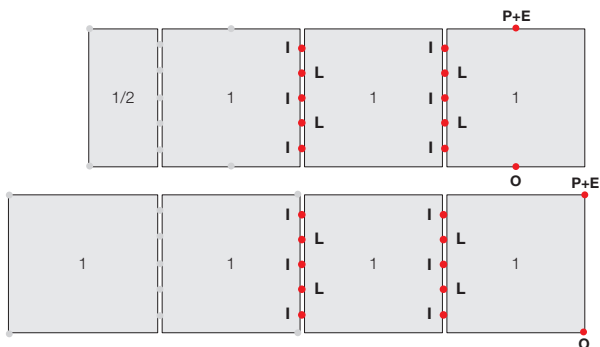
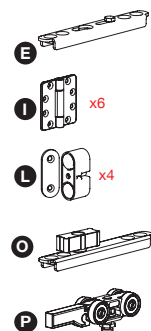

Kit for second door with floor guide
Kit per seconda porta con guida pavimento



Kit for second door with floor guide
Kit per seconda porta con guida pavimento



Butt hinges
Cerniere a libro



Magnetic aligner
Allineatore magnetico



Art. 1280



Art. 630

CODE	FINISHES / FINITURE		
K.0584.1.5	.41	.42	Max 2400 mm

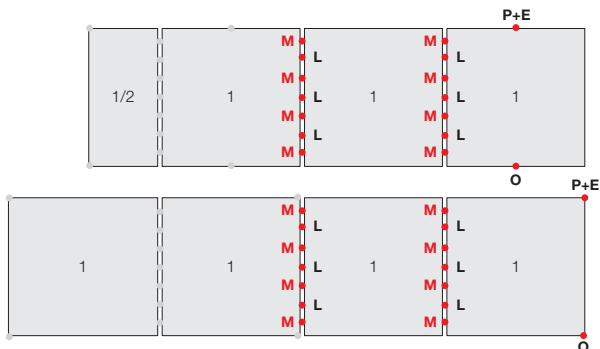
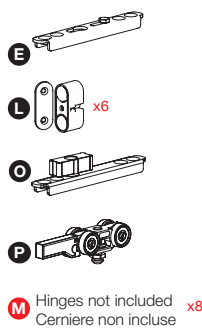

Kit for second door with floor guide
Kit per seconda porta con guida pavimento



Kit for second door with floor guide
Kit per seconda porta con guida pavimento



Without hinges
Senza cerniere



Magnetic aligner
Allineatore magnetico



Art. 1280



Art. 630

CODE	FINISHES / FINITURE		
K.0584.2.1	.41		Max 3000 mm

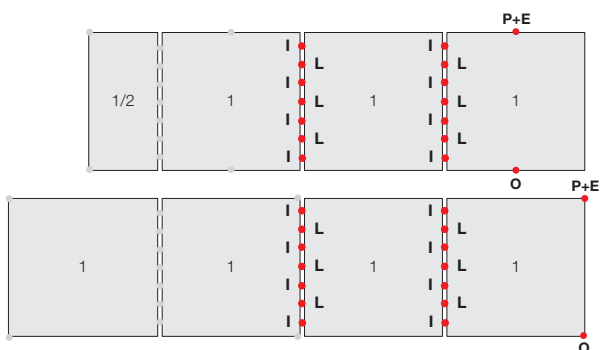
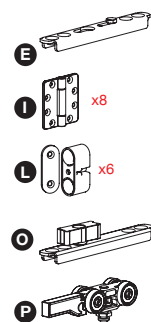

Kit for second door with floor guide
Kit per seconda porta con guida pavimento



Kit for second door with floor guide
Kit per seconda porta con guida pavimento



Butt hinges
Cerniere a libro



Magnetic aligner
Allineatore magnetico



Art. 1280



Art. 630

CODE	FINISHES / FINITURE		
K.0584.2.5	.41	.42	Max 3000 mm

CONFIGURATION TYPE: JAMB / TIPOLOGIA DI CONFIGURAZIONE: STIPITE

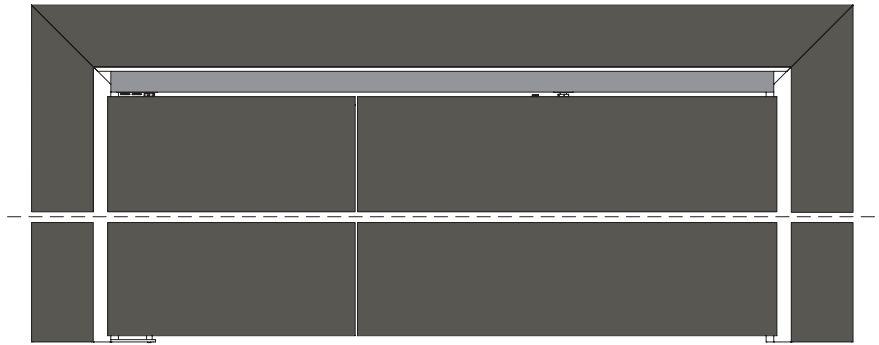
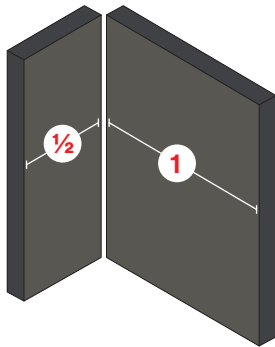

MEASUREMENTS DESCRIPTION / DESCRIZIONI MISURE

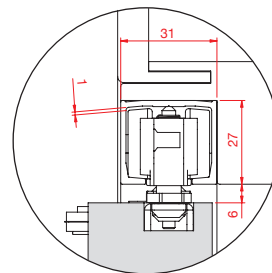
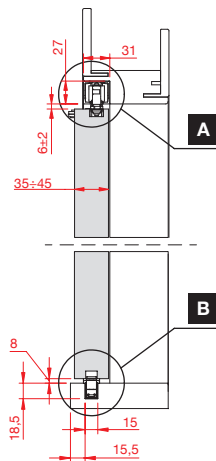
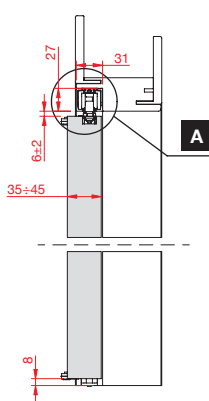
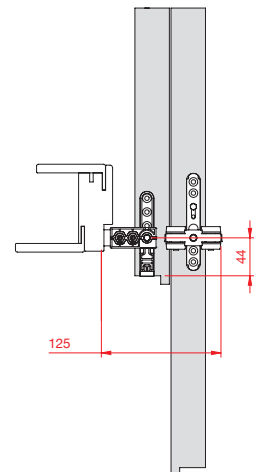
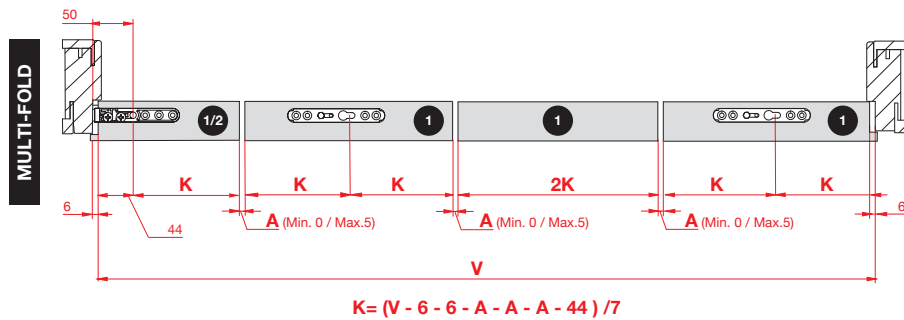
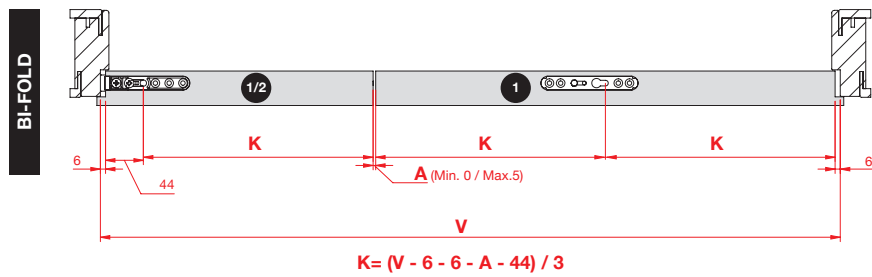

DETAIL / DETTAGLIO A

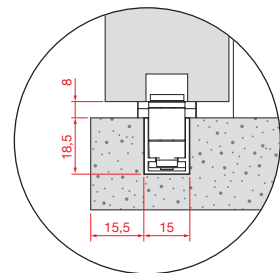

DETAIL / DETTAGLIO B

**RECESSED FLOOR TRACK
BINARIO INCASSATO A PAVIMENTO**

CONFIGURATION TYPE: JAMB / TIPOLOGIA DI CONFIGURAZIONE: STIPITE

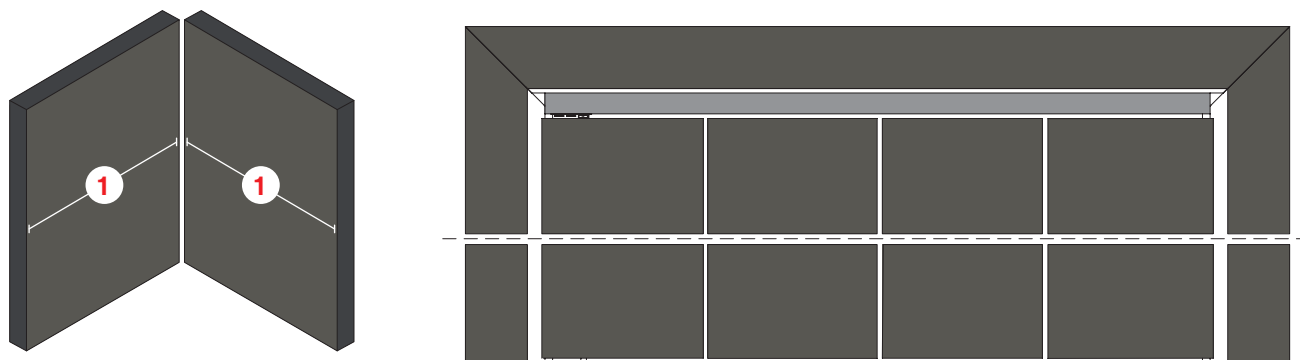

MEASUREMENTS DESCRIPTION / DESCRIZIONI MISURE

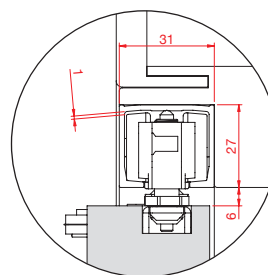
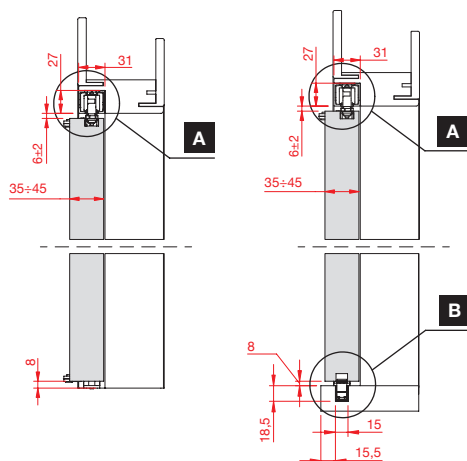
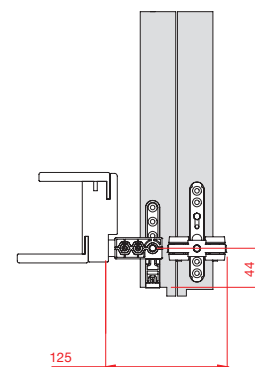
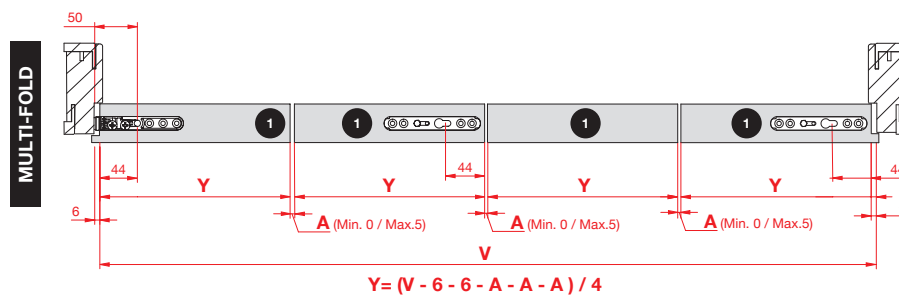
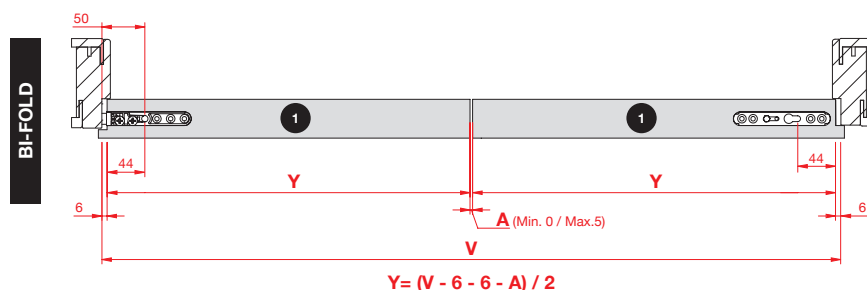

DETAIL / DETTAGLIO A

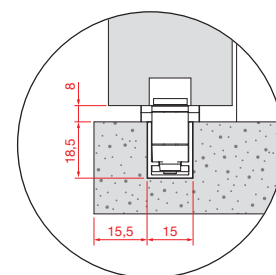

DETAIL / DETTAGLIO B
RECESSED FLOOR TRACK
BINARIO INCASSATO A PAVIMENTO

CONFIGURATION TYPE: CEILING RECESSED / TIPOLOGIA DI CONFIGURAZIONE: INCASSATO A SOFFITTO

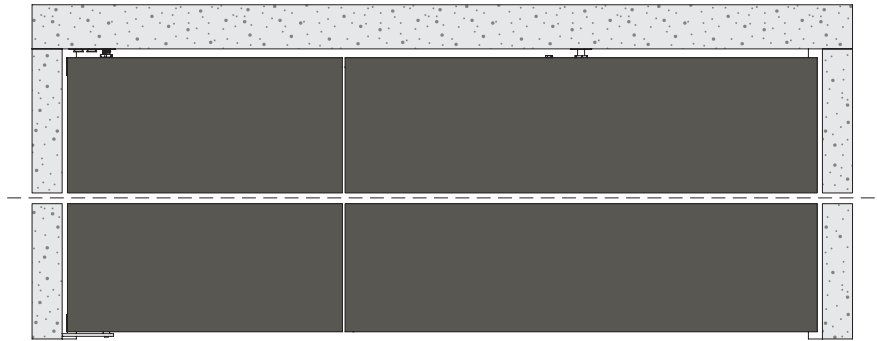
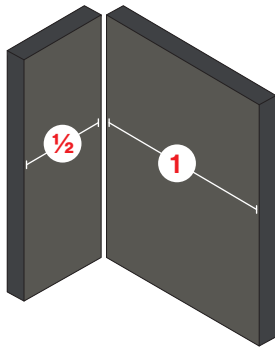

MEASUREMENTS DESCRIPTION / DESCRIZIONI MISURE

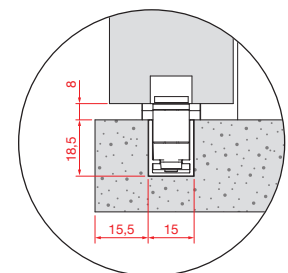
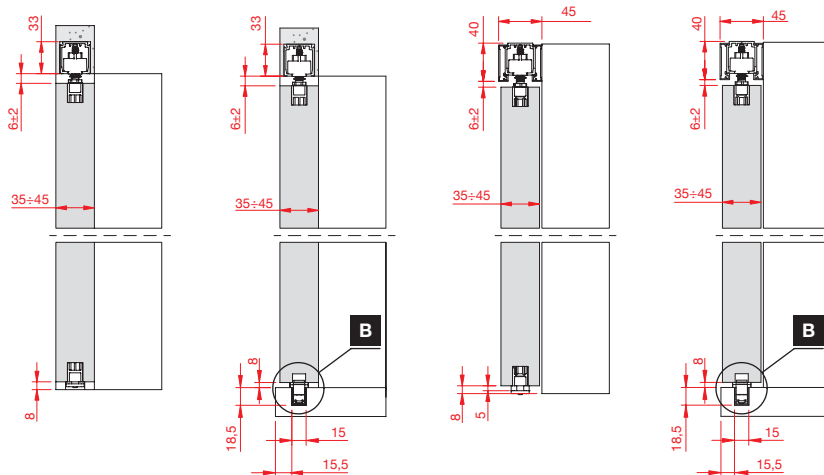
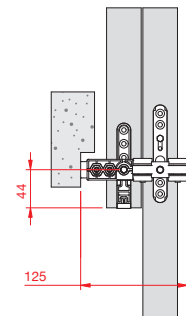
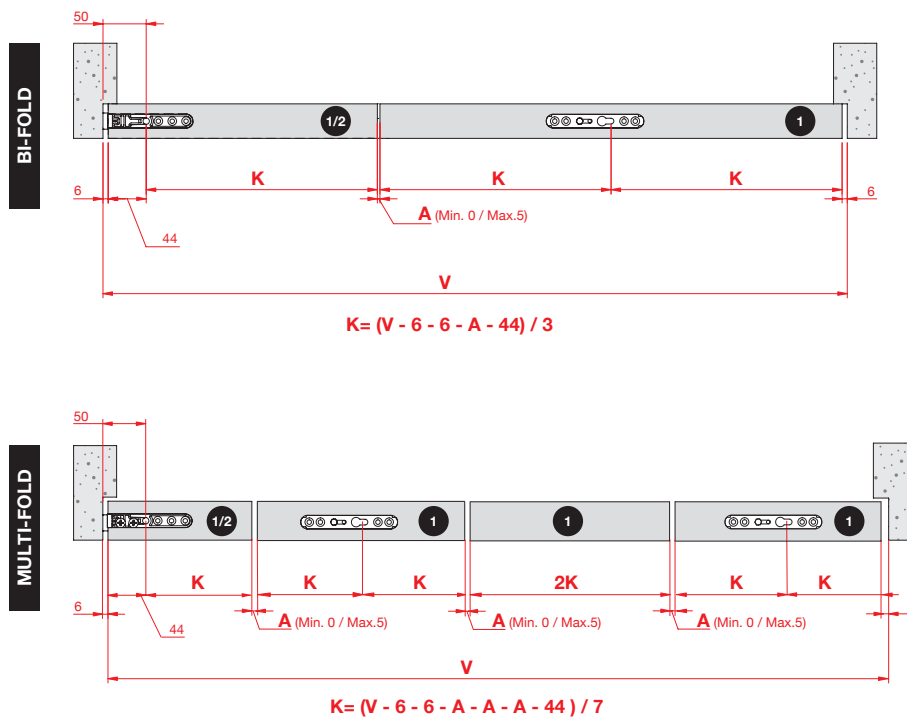

DETAIL / DETTAGLIO B
RECESSED FLOOR TRACK
BINARIO INCASSATO A PAVIMENTO

CONFIGURATION TYPE: CEILING RECESSED / TIPOLOGIA DI CONFIGURAZIONE: INCASSATO A SOFFITTO

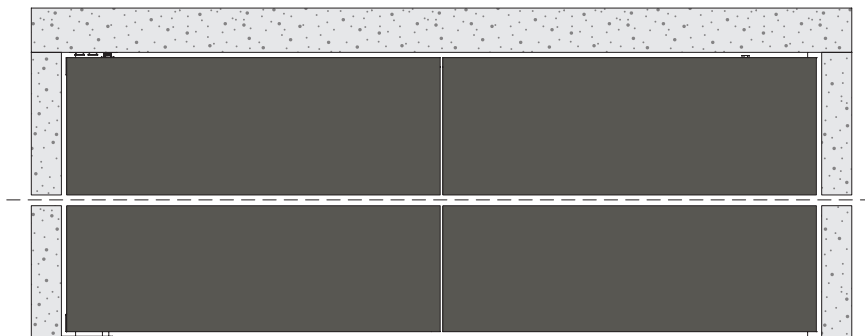
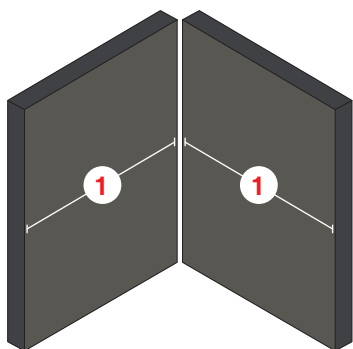

MEASUREMENTS DESCRIPTION / DESCRIZIONI MISURE

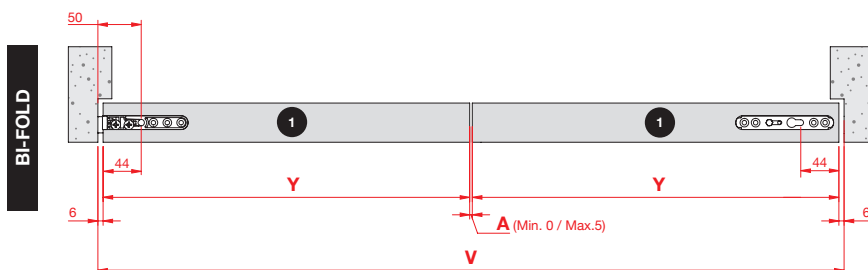

$$Y = (V - 6 - 6 - A) / 2$$

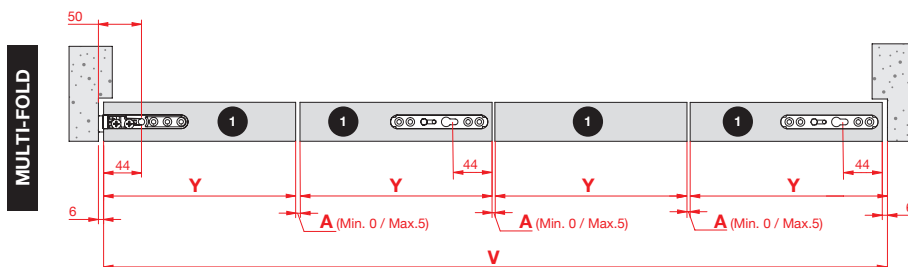

$$Y = (V - 6 - 6 - A - A - A) / 4$$

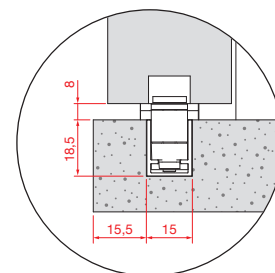
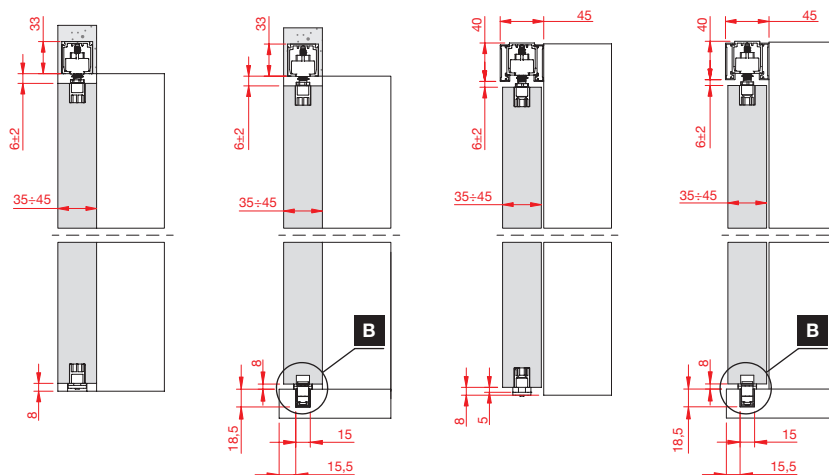
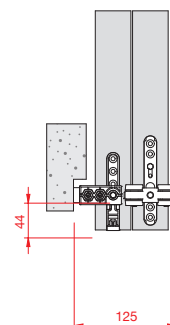

DETAIL / DETAGLIO B
RECESSED FLOOR TRACK
BINARIO INCASSATO A PAVIMENTO



Terno Scorrevoli S.p.A.

Via Ravenna, 4 - 20814 Varedo (MB) ITALY

Phone +39 0362 543001

terno@ternoscorrevoli.com

www.ternoscorrevoli.com